



Electronic Control Systems

Standard Products - Electronics



Master and Slave system



Connector with timer circuit - ETC1



DP Digital - ΔP Control



Sequencer - Model LCT4 - "UL" Approved



Sequencer - Model MTS



Sequencer with remote pilots - Model MTS PR 1/4"



Sequencer - Model MT



Economiser with ΔP - Model MPS



*Economiser with ΔP and remote pilots
Model MPS PR 1/4"*



Economiser with ΔP - Model MCS

Special Execution - Electronics



*Main Control Panels
with Mecair controllers*



*Slave system fully wired
and mounted to tank*



*Full Immersion system / Junction Box
and MPS Economiser prewired*



*Pneumatic Connections
in AISI with CSN Enclosure IP67*



Tank with Slave system and Remote Pilots including Pneumatic Connections



Fully Assembled Tank, CSN Enclosure with Pneumatic Connections in AISI and prewired to Electrical Board



Special Execution Wiring in accordance to ATEX Directive



PED or ASME Certified Tanks complete with Full Immersion Valves, Explosion Proof Pilots and Connection Flanges

DESCRIPTION

BUS System

The Mecair **MASTER** and **SLAVE SYSTEM** has been designed to command the sequence of diaphragm valves used in Pulse Jet Dust Collector Filters. The new "**BUS**" system consists of a "**MASTER CONTROLLER**" (**MSC**) and one or more "**SLAVE**" cards (Min. 1 - Max 20 Slave). The connection between each **SLAVE** card is very simple and requires a standard three wire gland cable (and not a special shielded cable). The standard cable is then connected to a standard three-pin DIN socket (without ground), which is then plugged directly into each slave card enclosure. The greater the number of diaphragm valves and the more convenient and cost effective becomes the system.

By using our system we are able to:

- Obtain a system which is pre-wired in zones
- Time saving in wiring
- Eliminating large quantity of wires being dragged from one end of the filter to the other
- Auto testing of system to ensure correct functioning of diaphragm valves
- No more laborious installation of wiring - Cost saving.

Master and **Slave Controller** is the intelligent part of system. It allows us to read the (Δp) and control the sequence of the diaphragm valves in the dust collector filter. The **Master Controller** is mounted in an enclosure (IP65).

The electronic controller uses microprocessor technology and all technical characteristics have been approved by an authorised laboratory. Clear menu and instructions allow ease of operation. The **Master Controller** allows the correct functioning of the entire system. Identifies eventual anomalies relative to the diaphragm valves and indicates this on the liquid crystal display. Localises and identifies problems with wiring or short circuit relative to the diaphragm valve. Ability to remotely visualize the (Δp) in the dust collector filter and as an option, ability to monitor the pressure in the header tank remotely.

The Slave, like the **Master Controller**, also utilizes microprocessor technology.

The Slave is mounted in an enclosure (IP 65).

The Slave allows ease of wiring in zones with up to a maximum of 10 valves per Slave.

The Slave has a push button mounted on the circuit board to automatically check the correct functioning of each diaphragm valve connected.

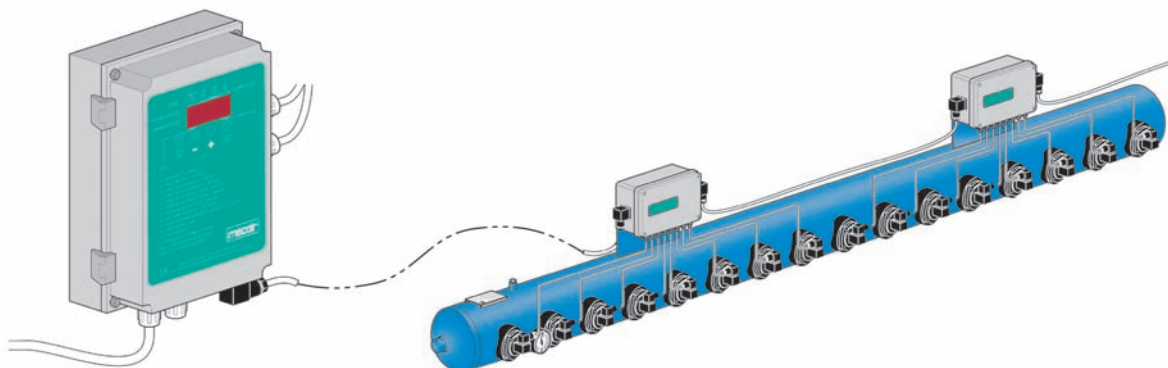

MAIN FEATURES
BUS System

- The MSC (Master and Slave) System controls the diaphragm valves mounted on dust collector filters, pulse-jet, whether they are bag filters or cartridge filters
- Main controller - Master with display and menu, for easy selection and setting of parameters
- Slave cards are modules of 10 outlets and up to a maximum of 20 slaves for a maximum of 200 valves
- Slave units available with PR1/4" remote pilots mounted within enclosure for pneumatic connections or stand alone slave for standard electrical connections
- 2 ΔP Set Points
- Automatic regulation of cleaning based on level of ΔP in the filter
- Easy selection - Manual or Automatic Mode
- Automatic search of diaphragm valves connected
- Shut Down Cleaning Function
- Low Pressure Alarm
- Remote Control
- Alarms
- Hour Counter
- Remote ΔP setting (Optional)

TECHNICAL CHARACTERISTICS	
Enclosure	Metal Enclosure - Powder Coated - Light Grey
Protection rating	Master - IP65 Slave - IP65
Dimensions	Master - 250x175x90 mm. Slave - 320x140x65 mm.
Weight	Master - 1,95 Kg. Slave - 1,10 Kg. Slave PR 1/4" - 3,4 Kg. (10 pilots)
Connections	Screw in Terminals – Max. 2.5 mm ² section
Temperature	Storage: -20°C / +80°C Working Temp: -10°C / +50°C, with duty cycle (intermittent) 30%
Power Inlet	Master inlet voltage: 115/230 V ($\pm 10\%$) - 50/60 Hz Slave Outlet: 24 V DC max 20W
Absorbed power	Total Absorbed Power: 35 VA - 230V - with 6 slaves Total Absorbed Power: 50 VA - 230V - with 10 slaves Total Absorbed Power: 70 VA - 230V - with 20 slaves Master - 2,5 VA Slave 1,5 VA
Relay	2 A - 250 V AC
Main fuse	500 mA - delayed for 115 V 260 mA - delayed for 230 V
Pulse time	0,01 \div 3,00 sec.
Pause time	1 \div 999 sec.
Pause time in automatic	1 \div 999 sec.
Range ΔP positive	0,01 \div 9,99 kPa
Range ΔP negative	-0,01 \div -0,50 kPa
Shut Down Cleaning-Cycles	0 \div 99 cycles
Shut down cleaning	Activated via external contact (normally open) free of power
Remote control	Activated via external contact (normally open) free of power
ΔP precoating	Activated via external contact (normally open) free of power
Hour counter	0 \div 999,999 hours

DESCRIPTION

ETC1

The electronic connectors model **ETC1** are timers with cyclical repetition of control. The load is supplied as soon as the power is switched on. The trimmer "ON" controls the ON-time for valve energising, whilst trimmer "OFF" sets the interval between two sequential times. The sequence is repeated for as long as the power supply remains connected. A "TEST" button is provided and two leds are used to show the state of the timer.
Note: The timer is supplied equipped with IP65 connector.



CONNECTOR	CODE	TIME
PG9	ETC1	0,5 / 10 sec.

TECHNICAL CHARACTERISTICS	
Supply Voltage	24 / 240V AC/DC - ± 10% 50/60 Hz
Max. Current	1 A
Current Consumption	4 mA max.
Operating Temp. range	-40°C / +60°C
Design standard	VDE 0110 - 1/89
Enviromental protection	IP65 assembled
Connection	DIN 43650A/ISO 440
Housing material	ABS Plastic FR grade
Off time	0,5 - 45 minutes
On time	0,5 - 10 seconds
Scale accuracy	± 10%
Indicators	YELLOW LED - ON phase YELLOW LED - OFF phase

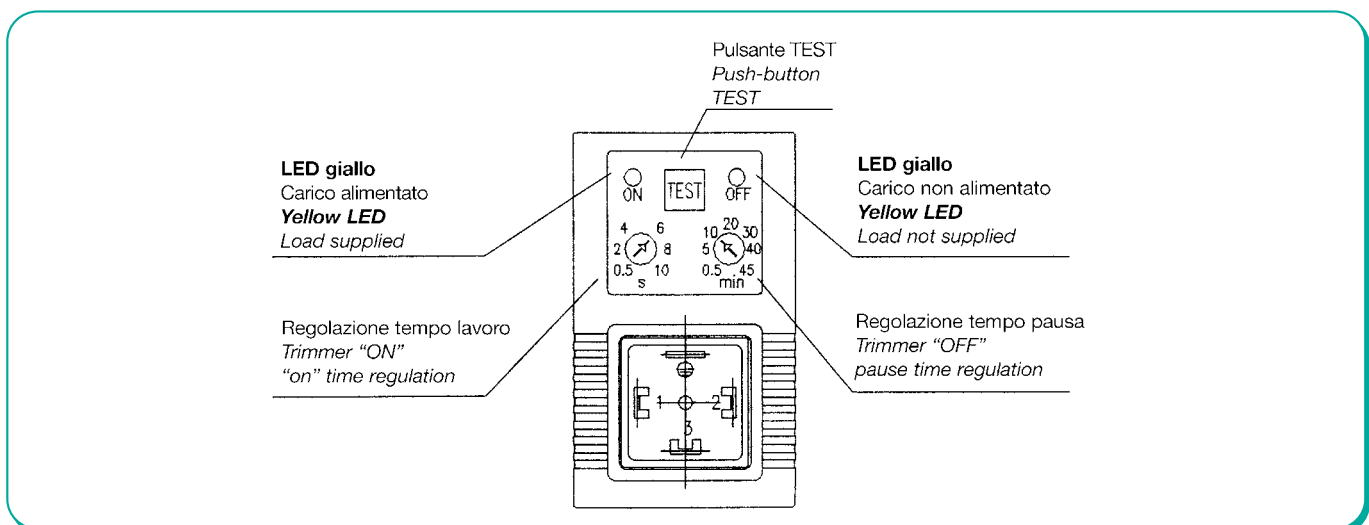
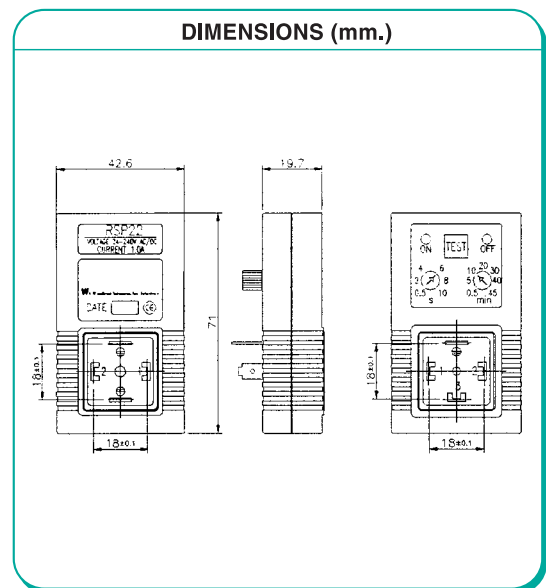

DESCRIPTION

DP Digital

The **DP Monitor** is a differential pressure monitor designed specifically for filter house applications.

The apparatus is available with 2 different mounting enclosures:

- Standard ABS Enclosure
- Din Rail Mounting enclosure

Grade of Protection for the Standard ABS Enclosure is IP65. Grade of Protection for the version with Din Rail mounting is IP54. IP65 protection rating available as an optional feature and obtained by adding a transparent front panel.

The DP Monitor is available in two versions:

- Micro DP** - Model DPD (ABS Enclosure-IP65)
- Model DPD-DIN (DIN Rail Mounting-IP54)
- Model DPD-DIN/IP65 (Optional - DIN Rail Mounting-IP65)

- Digital alphanumeric backlit display
- 5 languages easily selectable
- One set point
- Relay contact

- DP Super** - Model DPS (ABS Enclosure-IP65)
- Model DPS-DIN (DIN Rail Mounting-IP54)
- Model DPS-DIN/IP65 (Optional - DIN Rail Mounting-IP65)

- Digital alphanumeric backlit display
- 5 languages easily selectable
- High set point
- Low set point
- Alarm set point
- Separate relay for set point and alarm
- 4-20mA circuit, Active or Passive

All the units are supplied complete with two filter house sensors accessories to be mounted externally to the filter wall. One sensor tap for the dirty plenum and the other sensor tap for the clean air plenum. If installing the DP Digital as a pressure monitor with reference to the environment, you have to install just one filter house sensor and just one connection pipe. *Upon request it is possible to supply the unit in accordance with the European Directive EC/94/9 ATEX, ATEX II 3D (zone 22)*

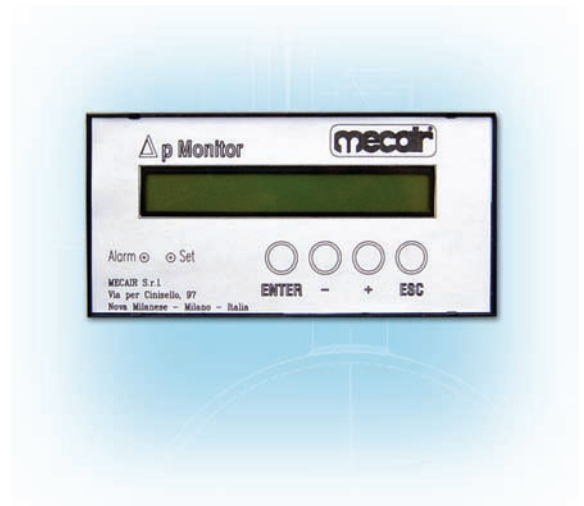

TECHNICAL CHARACTERISTICS	
Power Supply	115 / 230 V AC/DC - ± 10% 50/60 Hz
Power Absorption	2,5 VA
Range of Measure	0,01 ÷ 9,99 kPa
Zero Thermal Drift	Thermal Compensation ± 5‰
Linearity	± 2‰ ± 1‰ digit on scale kPa
Connections	Push in plugs - sez. max. 2,5 mm ²
Temperature	Warehousing: -20°C / +80°C Working: -10°C / +50°C
Dimensions	Version ABS Enclosure: 150 x 200 x 80mm Version DIN: 72 x 144 x 100mm
Weight	Kg. 0,80
Units of Measure	kPa - mm H ₂ O - " H ₂ O - m Bar - Inch

DESCRIPTION

TL06E

The electronic sequencer model **TL06E** is expressly designed to control the pulse times and interval times of diaphragm valves used in the application of dust collector filters (pulse-jet). The setting of the pulse times and pause times is simple with the use of a small digital display, while the microprocessor ensures the accuracy of the settings.

Upon request the unit can be supplied in accordance to the European Directive EC/94/9/ATEX, ATEX II 3D (zone 22). Excellent for installation in small filter bag houses or on silos / bin vents.

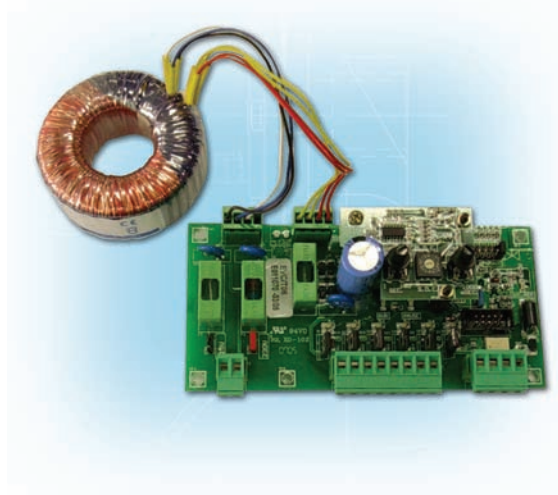

MAIN FEATURES

Main Features

- Enclosure in ABS (grey)
- Digital display allows easy selection of pause time and pulse times
- Selection of valves via a jumper
- Selection of inlet voltage via jumper – 115V 50/60Hz or 230V 50/60Hz
- Outlet voltage only 24V/DC
- Remote contact available to visualise values
- Shut down cleaning cycles selectable up to a maximum of 15 cycles

TECHNICAL CHARACTERISTICS	
Inlet Power supply	115 / 230 V AC/DC - ± 10% 50/60 Hz
Main fuses	230 V = 315 mA T - 115 V = 500 mA T
Output fuse	1 A T
Output Power supply	Only 24 V DC
Number of outputs	6 with jumper selection
Max output power	15 W
Pulse time	0,20 - 1 sec.
Pause time	1 - 180 Sec.
Remote control	Voltage free contact normally closed
Shut down start control	Voltage free contact normally closed
Box dimension	175 mm. x 125 mm. h x 75 mm.
Weight	0,85 Kg.

DESCRIPTION

LCT 4

The electronic microprocessor sequencer model **LCT-4** has been expressly designed to control the interval and pulse time of diaphragm valves, installed on reverse pulse-jet filters. All the technical characteristics satisfy **UL** approval.

The product has therefore been tested by an authorised laboratory which have issued a certificate which authenticates and verifies that the Mecair sequencer conforms with the **UL** approval.

LCT-4 is only available without the enclosure.

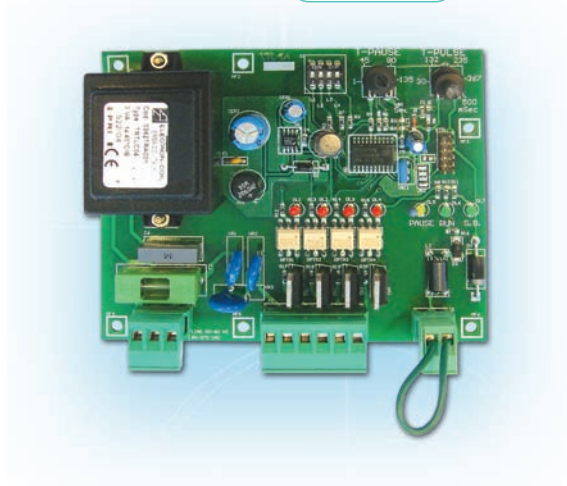

MAIN FEATURES

- Dip-switch selector n° of outputs
- Potentiometer to set pause and pulse time
- Supply range: 80-270 V 50/60 Hz (same inlet-outlet voltage available only)
- Timed sequential control of the diaphragm valves with zero-crossing to eliminate electrical interference
- Predisposition for external automatic regulator of the differential pressure in the filter or contact from PLC (Remote command)

TECHNICAL CHARACTERISTICS	
Power Supply	80 / 270 V AC/DC - ± 10% 50/60 Hz
Main Fuse	T 1A
Outlet	Same Inlet Voltage
Number of Outlets	4 - Selectable by Dip-switch
Max Outlet Power	80 VA / 115 V
Pulse Time	30 ÷ 500 mSec
Pause Time	1 ÷ 180 Sec.
Remote control	Activated via External Contact (normally closed) Free of Power 120
Connections	Push in terminal blocks - sez. max 2,5 mm ²
Dimensions	120 mm. x 97 mm. (3,82" x 4,70")
Weight	250 g

DESCRIPTION

MTS

The Model “**MTS**” sequencer has been designed to guarantee the control of diaphragm valves mounted on pulse jet dust collector filters containing filter bags or cartridges.

All the technical characteristics comply with the CE Directive. The MTS conforms to the European norm (89/336 EEC and 93/68 EEC).

Upon request it is possible to supply the unit in accordance to the European Directive EC/94/9 ATEX, ATEX II 3D (zone 22).

The MTS sequencer is available in the following versions: MTS4, MTS8, MTS12, MTS16

The MTS Sequencer allows you to set and visualise via the display:

- Number of valves
- Pulse Time
- Pause Time
- Number of Shut down cleaning cycles

When in shut down cleaning mode, the pause time is the same as that set in normal operation

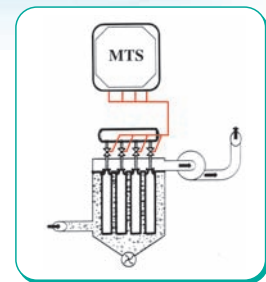

MAIN FEATURES

- Ability to regulate pulse time and pause time via a digital display
- Remote contact
- Shut down cleaning with number of cycles easily set
- Selection of inlet and outlet voltages (AC/DC)

DIMENSIONS MTS 4÷16 (mm.)

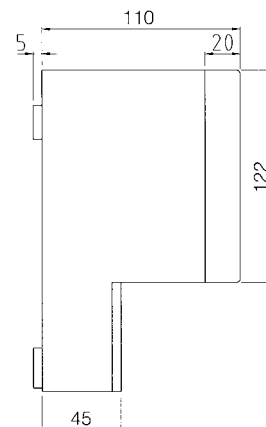
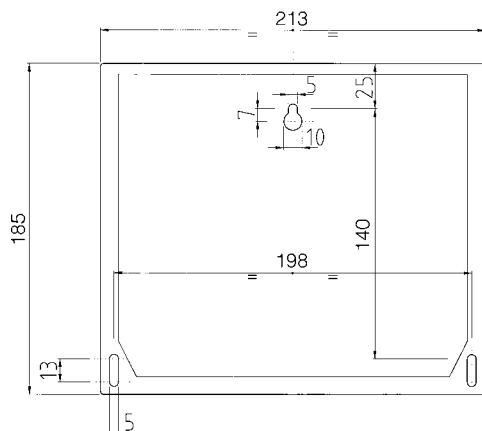

TECHNICAL CHARACTERISTICS	
Power Inlet	Standard: 115/230 V AC ($\pm 10\%$), 50/60 Hz (Selectable via jumpers) Optional: 24/48 V AC ($\pm 10\%$), 50/60 Hz
Number of Outlets	Minimum 2 - to Maximum 16 Outlets
Power Absorption	Without outlet: 2,5 VA. Outlet: 25 VA - 20 W
Pulse Time	0,01 ÷ 9,99 sec
Pause Time	1 ÷ 999 sec.
Remote Control	Activated via external contact (normally open) free of power.
Shut Down Cleaning	1 ÷ 99 cycles. To be operated from the normally closed contact of fan remote control switch.
Main Fuse	500 mA delayed 115/230 V 2 A delayed 24/48 V
Connections	Push in terminal blocks - max. Section 2,5 mm ²
Protection Rating	IP65
Temperature	Storage: -20°C / +80°C Working Temp: -10°C / +50°C, with duty cycle (intermittent) 30%
Dimensions	MTS 4-8-12-16 out: Box 213x185x113 mm.
Weight	Approx. 2 kg (all models)
Enclosure	ABS grey - transparent cover

* NB: for voltages 115 V AC and 230 V AC the inlet and outlet voltage has to be the same.

MTS PR 1/4"

DESCRIPTION

The Model **MTS PR1/4"-24/DC** sequencer is an integrated model which incorporates the remote pilot valves, model PR1/4", which can be pneumatically connected to the diaphragm valves type "VEM" rather than with electrical connections. This version has been designed to guarantee the control of diaphragm valves mounted on pulse jet dust collector filters containing filter bags or cartridges.

All the technical characteristics comply with the CE Directive. The MTS-PR1/4" conforms to the European Directive (89/336 EEC and 93/68 EEC).

Upon request it is possible to supply the unit in accordance to the European Directive EC/94/9 ATEX, ATEX II 3D (zone 22).

The pilots are mounted within the enclosure, are pre-wired and have a 1/4" gas female thread to be used for the pneumatic connections between the remote pilot and the diaphragm valve.

The MTSPR1/4" is available from a minimum of 2 pilot valves to a maximum of 16 pilot valves mounted within the enclosure.

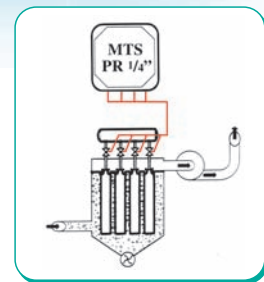

MAIN FEATURES

- Remote Pilot valves(Brass) pre-wired in enclosure complete with electronic sequencer
- Ability to regulate pulse time and pause time via a digital display
- Remote contact
- Shut down cleaning with number of cycles easily set
- Selection of inlet and outlet voltages (AC/DC)

GENERAL CHARACTERISTICS

Fluid	Air dry and oil free
Air inlet	1/4" Gas
Operating Pressure	From 0,5 to 7,5 bar
Exhaust	1/8" Gas

CONSTRUCTIVE CHARACTERISTICS

Pilot Body	Brass
Pilot	Brass
Lock Nut	Zinc plated
O-Ring	NBR

DIMENSIONS

MTS PR 1/4"

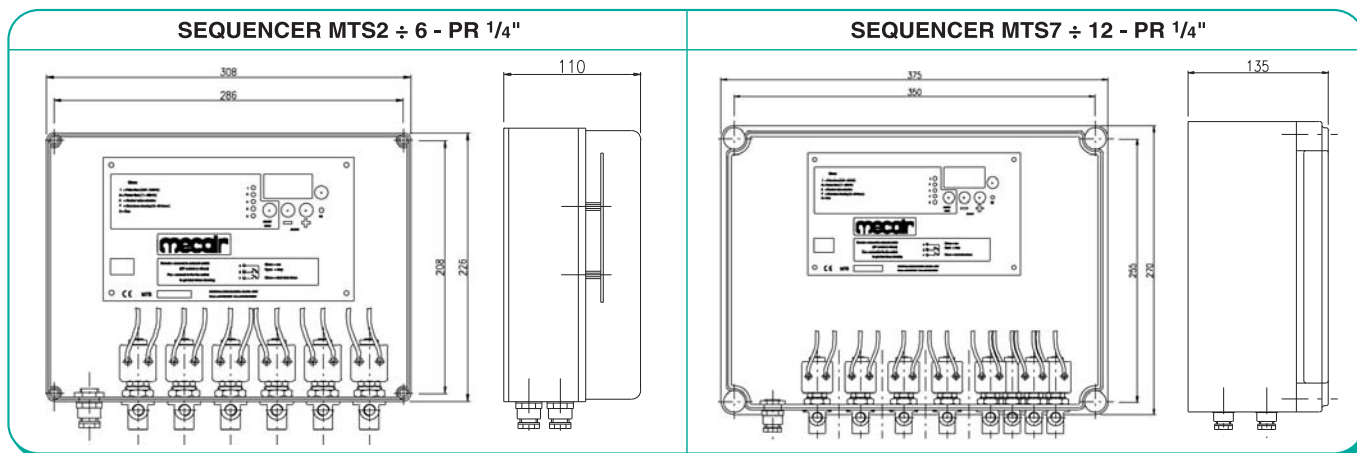

TECHNICAL CHARACTERISTICS

TECHNICAL CHARACTERISTICS		
Power Inlet	Standard: 115/230 V AC (±10%), 50/60 Hz (Selectable via jumper)	Optional: 24/48 V AC (±10%), 50/60 Hz
Number of Outlets	Minimum 2 - to Maximum 16 Outlets	
Power Absorption	Without outlet: 2,5 VA Outlet: 25 VA - 20 W	
Pulse time	0,01 ÷ 9,99 sec	
Pause time	1 ÷ 999 sec.	
Remote control	Activated via external contact (normally open) free of power	
Shut down cleaning	1 ÷ 99 cycles. To be operated from the normally closed contact of fan remote control switch	
Main fuse	500 mA delayed 115/230 V	2 A delayed 24/48 V
Connections	Push in terminal blocks section. max 2,5 mm ²	
Protection rating	IP65	
Temperature	Storage: -20°C / +80°C Working Temp: -10°C / +50°C, with duty cycle (intermittent) 30%	

DESCRIPTION

MT

The electronic microprocessor sequencer model “MT” uses advanced microprocessor technology, expressly designed to control the interval and pulse time of diaphragm valves, focusing on reverse pulse-jet systems with pneumatic cleaning procedures. All the technical characteristics satisfy the “CE” Directives which relate to the various protections relating to the terminal board, respecting the distances on the printed circuit boards, galvanic separation, etc. The product has therefore been tested by an authorised laboratory which have issued a certificate which authenticates and verifies that the Mecair product conforms with the following European Regulations: 89/336 EEC and 93/68 EEC.

The sequencer is available in the following versions:
Small enclosure: MT4 (4 outlets), MT8 (8 outlets) and MT12 (12 outlets);

Large enclosure: MT16 (16 outlets), MT20 (20 outlets), MT24 (24 outlets), MT28 (28 outlets) and MT32 (32 outlets).

The microprocessor sequencer contains a liquid crystal visual display which indicates the interval and pulse time, the number of cycles in the end cycle cleaning and the number of pauses between each end cycle cleaning. The unit automatically bypasses the loads not connected, allowing to command only the operative valves. There are two alarms: one for the short-circuit outlets, the other for microprocessor malfunction. The system can start up with a remote contact as well as by the switching off of the fan, to obtain the final cleaning cycle.

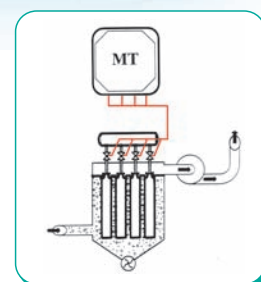

MAIN FEATURES

- Timed sequential control of the electric valves with zero-crossing to eliminate electrical interference.
- Predisposition for external automatic regulator of the differential pressure in the filter or contact from PLC (REMOTE command).
- Regulation of the pulse time and the pause time, with indication on the display.
- Short-circuit alarm and alarm for microprocessor malfunction.
- Easy selection of outlet voltage (AC/DC) and inlet voltage (AC).
- Setting number of end cycle cleaning. The final cleaning can start up with a remote contact as well as by switching off the fan.

DIMENSIONS

MT

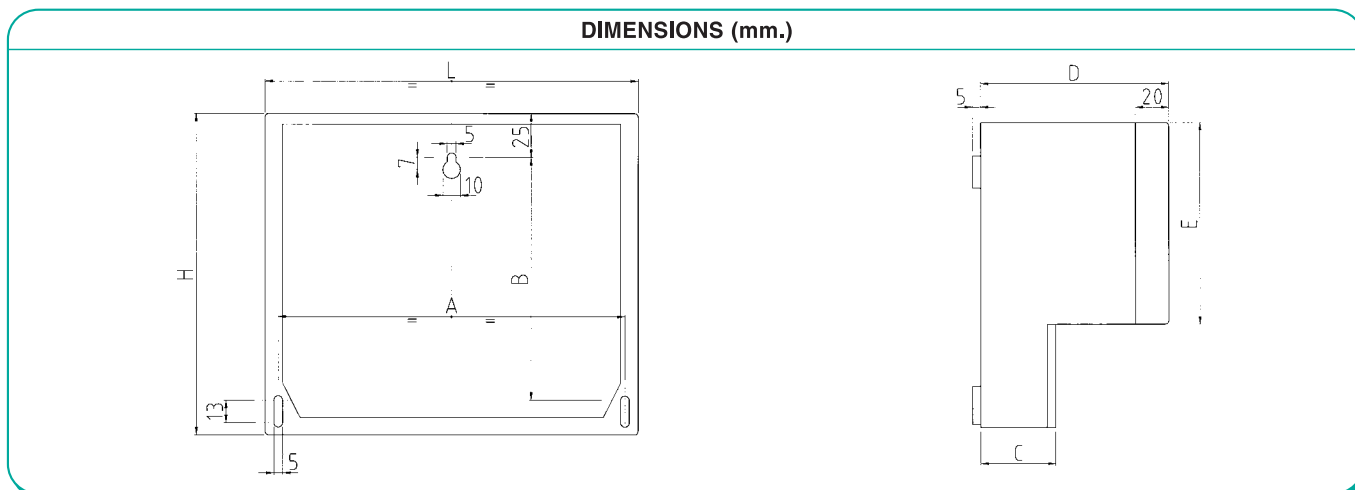

Model	L	H	A	B	C	D	E
MT 4÷12	213	185	198	140	45	110	122
MT 16÷32	296	256	280	210	50	118	193
MT 36÷48	560	280	534	255	–	130	–

TECHNICAL CHARACTERISTICS

TECHNICAL CHARACTERISTICS	
Power supply	Standard: 115/230 V AC (±10%), 50/60 Hz Optional: 24/48 V AC (+5% - 0%), 50/60 Hz (2 ranges possible via the selection of plugs)
Outlet	* Standard: 24/115/230 V AC - 50/60 Hz (3 ranges available via selection of plugs) IN - OUT 24 V AC Optional: 48 V AC
Number of outlets	On request from 4 to 32 (the intermediate models are suitable in multiple of 4)
Maximum outlet power	Input power: max 2,5 VA Outlet power: max 25 VA - 20 Watt
Pulse time	0,01 ÷ 9,99 sec
Pause time	1 ÷ 999 sec.
Remote	Activated via external contact (normally open) free of power.
End cycle cleaning	Activated via contact (normally closed) of the remote control switch of the fan.
Alarm relay	Watch Dog (electronic surveillance of the microprocessor) and short-circuit outlet.
Connections	Push in plug - max section 2,5 mm ²
Grade of protection	IP65
Temperature	Storage: -20°C / +80°C Operating: -10°C / +50°C
Dimensions	MT 4-8-12 (small enclosure): 212x185x115 mm. MT 16-20-24-28-32 (large enclosure): 296x256x118 mm.
Weight	MT 12: approx 2Kg. MT 32: approx 2,7 Kg.

DESCRIPTION

MPS

The Model “MPS” has been designed to guarantee the control of diaphragm valves mounted on pulse jet dust collector filters containing filter bags or cartridges. The main function of the MPS is to ensure the filter is cleaned only when it exceeds the set ΔP . All the technical characteristics comply with the CE Directive. The MTS-PR1/4” conforms to the European Directive (89/336 EEC and 93/68 EEC).

Upon request it is possible to supply the unit in accordance to the European Directive EC/94/9 ATEX, ATEX II 3D (zone 22).

The MPS sequencer is available in the following versions: MPS4, MPS8, MPS12, MPS16

The MPS unit visualizes all the values set, via a digital display (Operating ΔP , Pulse time, pause time, number of shut down cleaning cycles).

The pause time used when in shut down cleaning mode is the same as the pause time set when in manual mode.

The MPS unit also has the “PRECOATING” function, which allows the user to set a higher value of ΔP than normally required. (This is normally possible only once when the filter is new or when the filtering elements are new). This function is used in filters where it is necessary to ensure that the filtering elements absorb special re-agents which act as a further protection. By setting a higher ΔP value (Pre coating ΔP value), it allows the filtering elements to properly absorb the re-agents injected into the filter. Once the Precoating ΔP value has been reached the pulsing will commence and will cease once it reaches the normal operating ΔP value. This value will no longer be considered in the normal functioning of the filter.

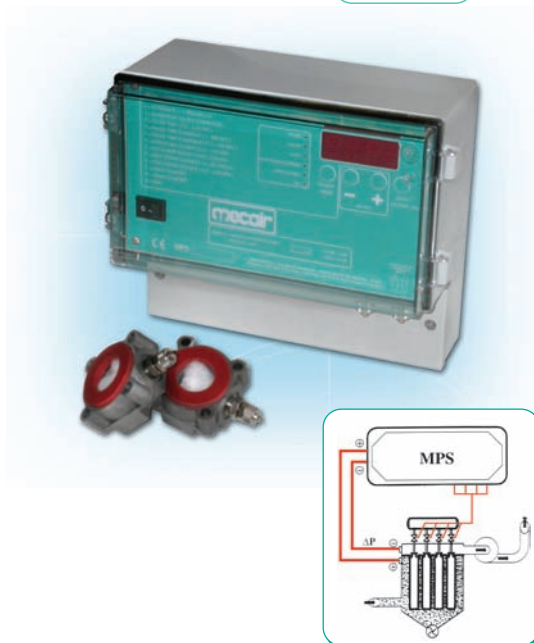

MAIN FEATURES

- Operates in MANUAL or AUTOMATIC(ΔP) mode
- Automatic start up of cleaning cycle according to set ΔP
- SHUT DOWN CLEANING with selectable number of cleaning cycles
- PRECOATING function for new filters or filters equipped with new filtering elements
- REMOTE function
- ALARM contact enabling connection to external alarms
- HOUR COUNTER
- ΔP value playback (option)
- 4 - 20 mA ΔP output (optional)

DIMENSIONS

MPS

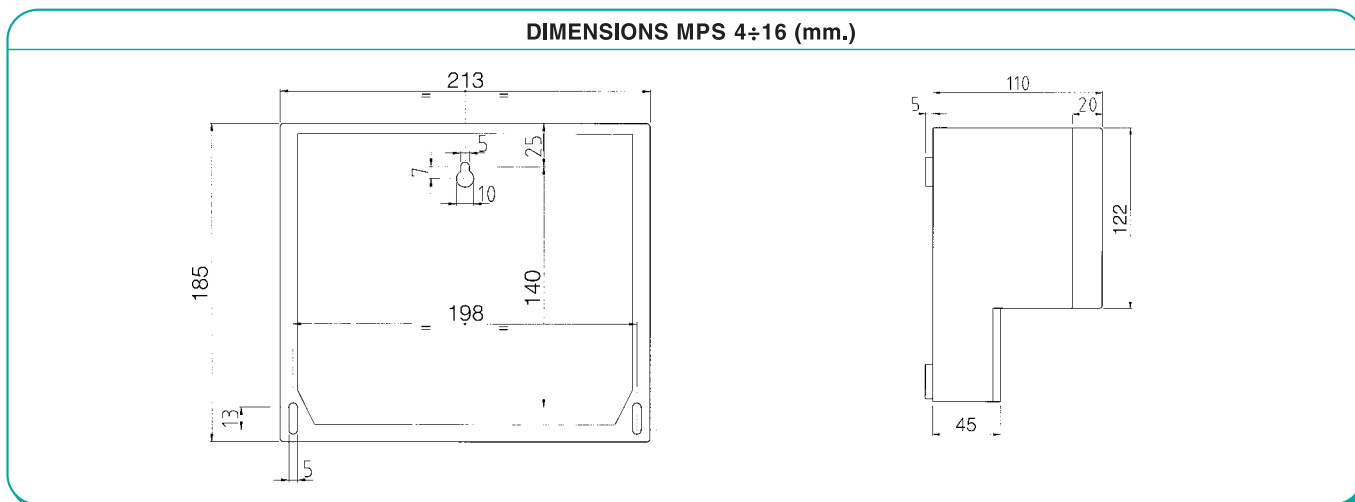

TECHNICAL CHARACTERISTICS

TECHNICAL CHARACTERISTICS	
Enclosure	ABS grey - transparent cover
Protection rating	IP65
Dimensions	MPS 4-8-12-16 outlets: enclosure 213x185x133 mm.
Weight	Approx 2 Kg.
Connections	Terminal blocks - max.section 2,5 mm ²
Temperature	Storage: -20°C / +80°C Operation: -10°C / +50°C, with duty cycle (intermittent) 30%
Power Inlet	Standard: 115/230 V AC (±10%), 50/60 Hz Optional: 24/48 V AC (±10%), 50/60 Hz (Selectable via jumpers)
Outlet Power	* Standard: 24/115/230 V AC - 50/60 Hz (In and Out upon Request) IN - OUT 24 V DC Optional: 48 V AC
Absorbed power	Without outlet: 25 V A - 20 W
Relay	2 A - 250 V AC
Main fuse	500 mA - delayed 115 V / 230 2 A delayed 24/48 V
Pulse time	0,01 ÷ 9,99 sec.
Pause time	1 ÷ 999 sec.
Pause time in automatic	1 ÷ 999 sec.
Operating ΔP	0,01 ÷ 2,50 kPa
Set alarm ΔP	0,01 ÷ 2,50 kPa
Shut down cleaning	0 ÷ 99 cycles
Remote control	To be operated from a non-powered external contact (normally open).
ΔP precoating	0,01 ÷ 2,49 kPa
Hour counter	0 ÷ 65,999 hours

MPS PR 1/4"

DESCRIPTION

The Model **MPS PR1/4"** - 24/DC" economiser is an integrated model which incorporates the remote pilot valves, model PR1/4", which can be pneumatically connected to the diaphragm valves type "VEM" rather than with electrical connections.

This version has been designed to guarantee the control of diaphragm valves mounted on pulse jet dust collector filters containing filter bags or cartridges.

All the technical characteristics comply with the CE Directive. The MPS-PR1/4" conforms to the European Directive (89/336 EEC and 93/68 EEC).

Upon request it is possible to supply the unit in accordance to the European Directive EC/94/9 ATEX, ATEX II 3D (zone 22).

The pilots are mounted within the enclosure, are pre-wired and have a 1/4" gas female thread to be used for the pneumatic connections between the remote pilot and the diaphragm valve. The MPSPR1/4" is available from a minimum of 2 pilot valves to a maximum of 16 pilot valves mounted within the enclosure.

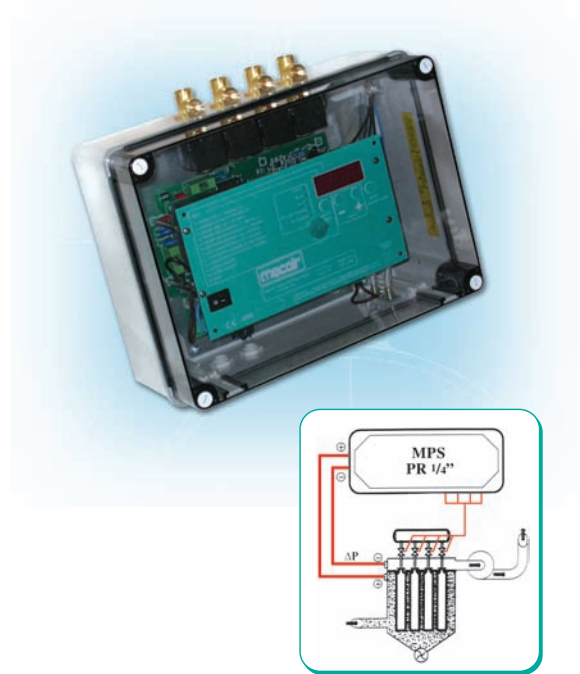

MAIN FEATURES

- Automatic start up of cleaning cycle according to set DP
- Remote Pilot valves(Brass) pre-wired in enclosure complete with electronic economiser controller
- PRECOATING function for new filters or filters equipped with new filtering elements
- Operates in MANUAL or AUTOMATIC(ΔP) mode
- SHUT DOWN CLEANING with selectable number of cleaning cycles
- REMOTE function
- ALARM contact enabling connection to external alarms
- HOUR COUNTER
- DP value playback (option)
- 4 - 20 mA ΔP output (optional)

GENERAL CHARACTERISTICS	
Fluid	Air dry and oil free
Air inlet	1/4" Gas
Operating pressure	Da 0,5 a 7,5 bar
Exhaust	1/8" Gas

CONSTRUCTIVE CHARACTERISTICS	
Pilot body	Brass
Pilot	Brass
Lock nut	Zinc plated
O-Ring	NBR

DIMENSIONS

MPS PR 1/4"

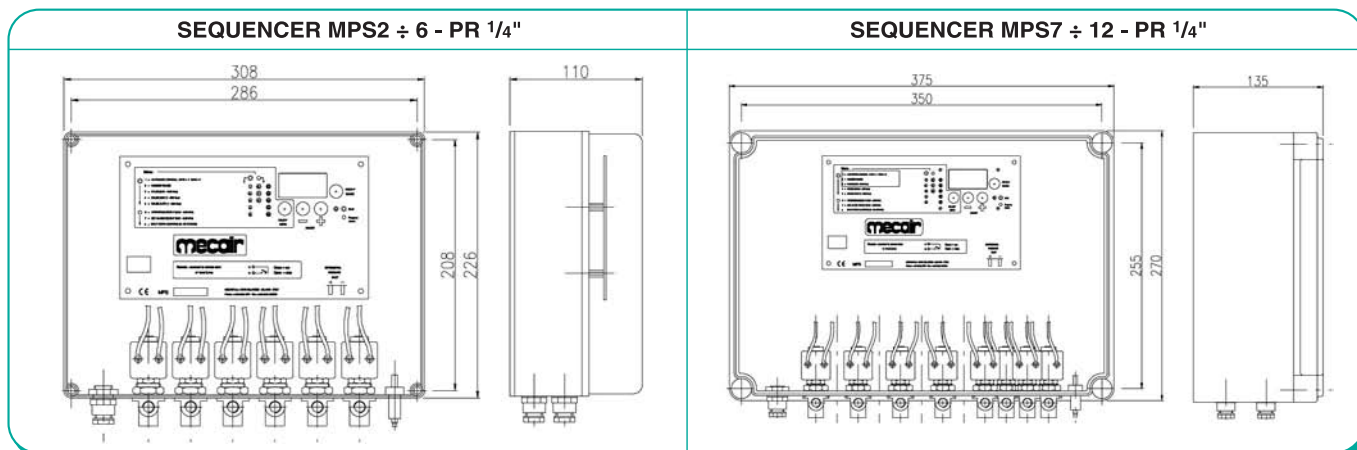

TECHNICAL CHARACTERISTICS

TECHNICAL CHARACTERISTICS	
Enclosure	ABS grey - transparent cover
Protection rating	IP65
Connections	Terminal blocks - max.section 2,5 mm ²
Temperature	Storage: -20°C / +80°C Operation: -10°C / +50°C, with duty cycle (intermittent) 30%
Power Inlet	Standard: 115/230 V AC (±10%), 50/60 Hz Optional: 24/48 V AC (±10%), 50/60 Hz (Selectable via jumpers)
Absorbed power	Without outlet: 25 V A - 20 W
Relay	2 A - 250 V AC
Main fuse	500 mA - delayed 115 V / 230 2 A delayed 24/48 V
Pulse time	0,01 ÷ 9,99 sec.
Pause time in manual	1 ÷ 999 sec.
Pause time in automatic	1 ÷ 999 sec.
Operating ΔP	0,01 ÷ 2,50 kPa
Set alarm ΔP	0,01 ÷ 2,50 kPa
Shut down cleaning	0 ÷ 99 cycles
Remote control	To be operated from a non-powered external contact (normally open).
ΔP precoating	0,01 ÷ 2,49 kPa
Hour counter	0 ÷ 65,999 hours

DESCRIPTION

MCS

The economist model “**MCS**” uses advanced microprocessor technology, expressly designed to control the interval and the pulse time of diaphragm valves using the DP and focusing on reverse pulse-jet systems with pneumatic cleaning procedures. All the technical characteristics satisfy the “CE” Directives which relate to isolation and low voltage power. The unit has been tested by an authorised institute and is in conformity with the European Regulation 89/336 EEC and 93/68 EEC.

The MCS is available with a minimum of 4 outlets (MCS4) up to a maximum of 128 outlets (MCS128).

The intermediate models increment in multiples of 4 (MCS4, MCS8, MCS12, etc.).

The principle of the MCS is as follows: an internal sensor registers the progress of the DP in the filter and when it exceeds the value of the set DP, the unit automatically sends a signal to the diaphragm valves in sequence (skipping the outlets which are not connected or where there is no charge recognised). The unit also allows you to set the **MANUAL CYCLE TIME** (this is the time it takes for all the valves to complete an entire cleaning cycle). This way you obtain the automatic regulation of the **Pause Time** between one valve and the next. All this is possible thanks to a sophisticated algorithm, which is able to automatically optimize the **Pause Time**, starting from the set **Manual Cycle Time**. On the digital display of the unit, you are able to identify all the operating values, such as the **Set DP**, **DP Alarm**, **Pause Time**, **Hour Counter**, **No. of cycles for Shut Down Cleaning** and the **relative Pause Time**.

The Economist also has the **PRECOATING** function, which subordinates the start of the cleaning cycle until such time that a preset DP value for **PRECOATING** has been reached (this DP value has to be greater than the **Set DP**). This allows the filtering elements to overload with reagents and preparation powders. It is possible to set an independant value for the **DP ALARM** as well.

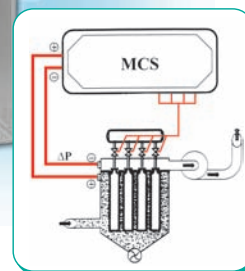

MAIN FEATURES

- Timed sequential control of the electronic valves with zero-crossing to eliminate electrical interference.
- Short-circuit alarm, microprocessor malfunction alarm and alarm of exceeded DP.
- Regulation of the set DP, pulse time, no. of cycles in final cleaning, with indication on the display.
- Setting of the **MANUAL CYCLE TIME** (this is the time it takes for all the valves to complete an entire cleaning cycle).
- **PRECOATING** function (start of the cleaning sequence subordinated to the achievement of the DP **PRECOATING**), for filters that have to be overloaded with reagents and preparation powders.
- Easy predisposition outlets voltage (AC/DC) and inlet voltage (AC).
- Automatic system for the command of one or more cycles for the final cleaning.
- Hour counter (indicates the number of hours which the filter has actually worked. From 0 to 9999 hours).

DIMENSIONS

MCS

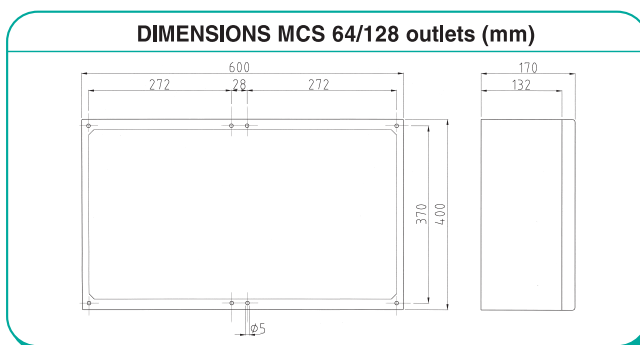
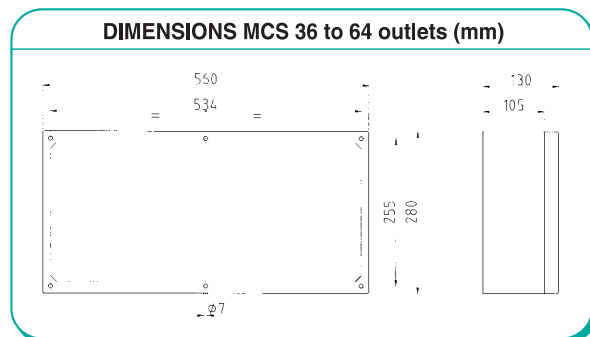
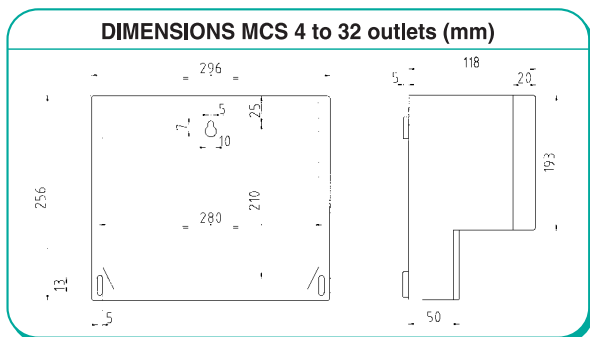

TECHNICAL CHARACTERISTICS

TECHNICAL CHARACTERISTICS	
Enclosure	Grey ABS - transparent cover
Grade of protection	IP65
Dimensions	MCS 4÷32: enclosure 296x256x118 MCS 36÷64: enclosure 560x280x130 MCS 68÷128 enclosure 600x400x170
Connections	Push in plugs - with max. wire section of 2,5 mm ²
Temperature	Storage: -20°C / +80°C Operating: -10°C / +50°C
Weight	MCS32: approx. 3,3 Kg. MCS48: approx. 7 Kg. MCS128: approx. 9,1 Kg.
Power supply	Standard: 115-230 V (±10%) - 50/60 Hz (AC/DC) Optional: 24 VDC / 24÷48 V (±10%) - 50/60 Hz
Outlets	Standard: 4-115-230 V (3 ranges available via selection of plugs) Optional: 48 V AC IN - OUT 24 V AC
Number of outlets	Min. 8 - Max. 128 (intermediate models are available in multiple of 4)
Power	Input power: max 2,5 VA Output power: max 25 VA/AC - 20 Watt/DC, with maximum pulse time 1 sec.
Pulse time	0,01 ÷ 9,99 sec.
Manual cycle time	1 ÷ 999 sec.
Set ΔP	0,01 ÷ 9,99 kPa
Set ΔP alarm	0,01 ÷ 9,99 kPa
Precoating	0 ÷ 9,99 kPa
N° cycles in final cleaning	0 ÷ 99 times
Hourcounter	0 ÷ 65,999 hours

Mecair S.r.l.

Via per Cinisello 97
20054 Nova Milanese - Milano
ITALY

Tel.: +39 0362 3751

Fax: +39 0362 367279

email: mecair@mecair.it

www.mecair.it

www.cleanairsystems.com

EUROPE

• **Tyco Umwelttechnik**
Im Petersfeld 6
D-65624 Altendiez
GERMANY
Tel.: +49 6432 1001/1002
Fax: +49 6432 63810

• **Goyen Controls Co UK Ltd**
Unit 3B Beechwood
Chineham Business Park
Basingstoke, Hampshire, RG24 8WA
UNITED KINGDOM
Tel.: +44 1256 817 800
Fax: +44 1256 843 164

ASIA PACIFIC

• **Goyen Controls Co Pty Ltd**
268 Milperra Road
Milperra
NSW 2214 AUSTRALIA
Tel.: +61 2 9792 0201
Fax: +61 2 9771 5380

• **Goyen S.R.O.**
Shanghai Representative Office
2521 Zhao Feng World Trade Building
369 Jiang Su Road Shanghai 200050 CHINA
Tel.: +86 21 5239 8810
Fax: +86 21 5239 8812

USA

• **Goyen Valve Corporation**
1195 Airport Road
Lakewood
New Jersey 08701 USA
Tel.: +1 732 364 7800
Fax: +1 732 364 7839